

# PRODUCT CATALOG

**DeGelman**

ENGINEERED TOUGH



**PRO-TILL  
PRO-CAST  
TRUGRADE  
LANDROLLERS  
ROCK REMOVAL  
HEAVY HARROWS  
BULLDOZER BLADES  
MANURE SPREADERS  
CUTTING EQUIPMENT  
HD STAGGERED RIPPER**



High Performance Agricultural Equipment



Scan for Homepage

**BUILD IT TOUGH,  
BUILD IT HEAVY,  
BUILD IT TO LAST,  
FROM TOP TO BOTTOM.**

- Wilf Degelman

*W. J. Degelman*

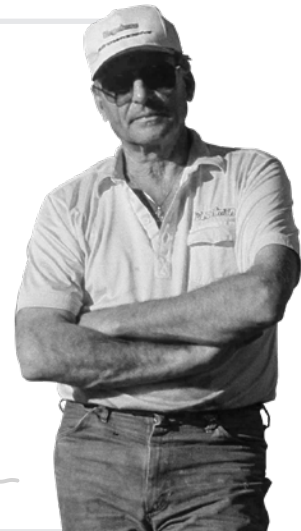

## ENGINEERED TOUGH

Wilf Degelman started Degelman Industries over 60 years ago with one thing in mind. He wanted to make products that had a true impact on the farm. Wilf was raised on farm values, not business values. He believed in honesty, being upfront, and was always interested in what farmers were doing and where they thought the industry was headed. He understood the costs associated with farming and set out to make practical equipment that would make seeding and harvesting easier.

In 1962 Wilf Degelman built a heavy duty rock picker, the product that started it all, out of his barn in Raymore, SK. Fast forward to today, and we still build all Degelman products with his philosophy in mind; "The fewer number of parts and complexity the better - and when you build something, build it right, build it heavy and build it to last - from top to bottom."

We focus on support and make the experience of owning a Degelman unlike any other. We are a well established company, with deep roots in the agricultural industry. We take exceptional pride in what we do, and manufacture every piece of equipment with extreme focus and care. We go above and beyond, like the marks you'll find on our equipment to show the torque has been done right, and creating easy to follow quick-start manuals, so you're ready to roll on a Sunday morning. We make all of our products with the farmer's needs in mind.

Over the last 6 decades, there have been great advances in technology, but the foundation of Degelman remains the same: build simple, heavy, reliable equipment, that will last for generations. We choose to innovate rather than imitate, and work hard to remain an industry leader. Wilf truly said it best: "Build it right, build it heavy and build it to last - from top to bottom".

Degelman. Engineered Tough.

**Degelman**



**1970**  
Dozer King

**1990**  
6900 Series  
Bulldozer Blade



**1962**  
Flotation Hi-Lift  
Rock Picker

**1984**  
Super Picker

**1996**

Signature 7200  
Series Rock Picker



**1992**

Landroller



**1993**

Strawmaster

**2002**  
Mowing Equipment

**2013**

Pro-Till



**2010**  
Manure Spreaders

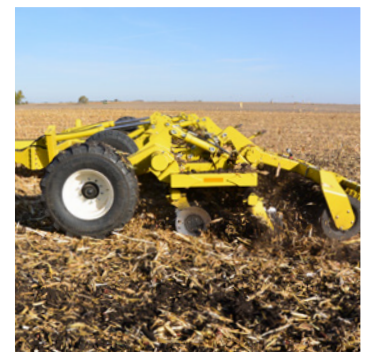

**2004**

7900 Series

**2024**

HDSR



**2021**  
Pro-Cast

**2020/21**

Strawmaster + & Strawmaster X

**2019**  
Silage King



**2023**  
TruGrade

**2018**  
Rock King



Super Picker III



Scan to view a comprehensive list of our product releases throughout the year



# TRUE GREASELESS TECHNOLOGY

Put away the grease gun. We know the window for spring and fall work is quick and unforgiving. Give yourself the upper hand with Degelman's game changing True Greaseless Technology.

Farming operations are becoming bigger and more complicated every day. We know time is money, and that today's growers have more to worry about than greasing their equipment. We have invested time and money, and are committed to bringing True Greaseless Technology to all products we develop. Any product name with the TGT marking on it, features our industry leading True Greaseless Technology.

## Pin Eye Cylinders

The welded pin eye cylinder series is designed to withstand the most demanding applications on the market today. The manufacturer's extensive design experience has resulted in a premium rephasing cylinder with the latest in sealing and rephasing technology and induction hardened rods for the ultimate in corrosion protection and durability.



## Exclusive Self-Lubricated, Zero-Maintenance Bushings

No metal on metal contact with our state of the art bushings. These bushings, manufactured from a friction liner applied on a glass fiber structure, have excellent friction properties and improved wear resistance without external lubrication even on high loads.



## Bushing Seal

The wiper edge removes even the toughest dirt and contaminants from the pin, keeping the system running clean and at its peak performance. The metal enclosure ensures a secure fit in the open housing, preventing expulsion of the wiper even under extreme conditions.

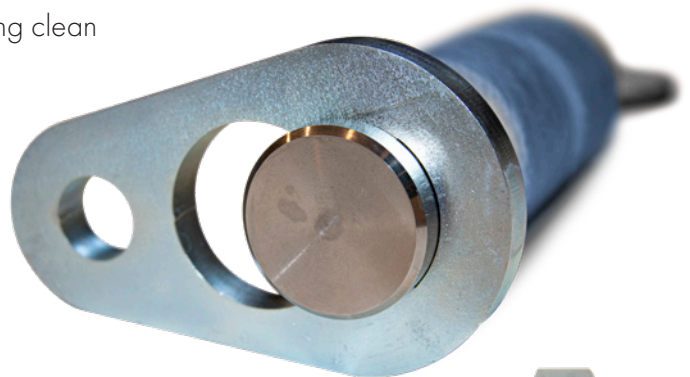

## Oversized Electroless Plated Nickel Pin

At 2" - 2.5" in diameter, these high tensile steel pins are 60% larger than any other pin on the market. With the robust weld free pin design, you don't have to worry about a weld breaking and stopping you from getting your work done.

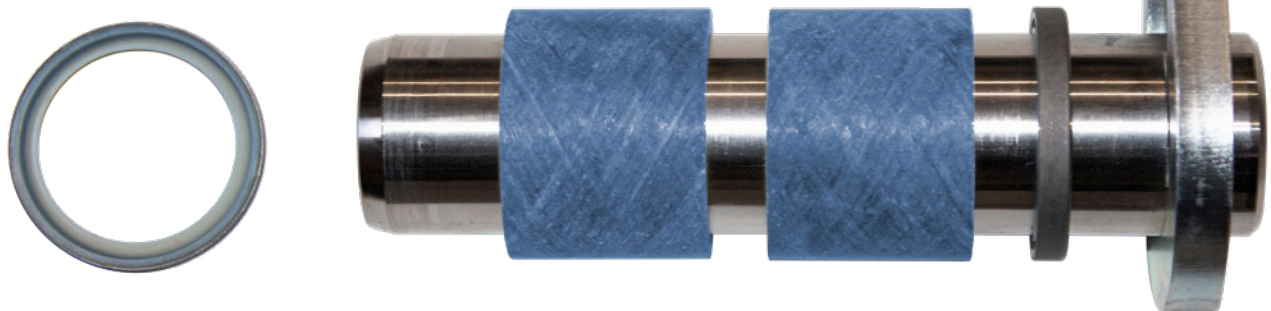

# PRO-TILL

## High Performance Tillage

This is Pro-Till by Degelman. The fastest and most versatile piece of tillage equipment you will ever own. Pro-Till shreds heavy fall residue, opens up spring fields, levels ruts, destroys clods and produces an absolutely perfect seed bed. Pro-Till is High Speed, High Performance Tillage.

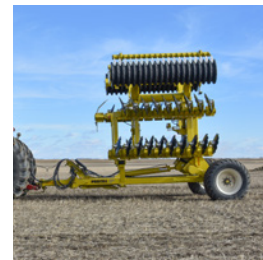

### Horsepower Requirements for All Sizes

- 12 to 15 hp per foot at **2" or less working depth** to achieve 8-12 mph with 20" blades (will vary by soil type)
- 15 to 20 hp per foot at **2" or more working depth** to achieve 8-12 mph with 20" blades (will vary by soil type)

Pro-Till Model	Horsepower Per Foot			⊘
	12hp	15hp	20hp	
10'	200	250	300	✓
13'	260	325	390	✓
14' NT	170	210	280	✓
17' NT	200	250	350	✓
20'/20'NT	250	300	400	✓
26'	300	400	500	✓
30'	360	450	600	✓
36'	450	550	600	✓
40'	500	600	600+	
41'	500	600	600+	✓
45'	550	600+	600+	✓



# PULLED AT SPEEDS OVER 10 MPH

The Pro-Till shreds residue at speeds over 10 mph, up to three times the speed of traditional cultivators, while ensuring uniform distribution of residue to eliminate problems such as uneven and delayed emergence, hair pinning, erosion and seeder/planter plugging.



## EXCLUSIVE OPTIONS

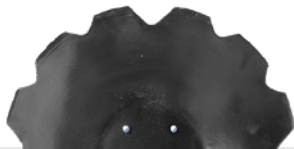

**Double V Disc**

The Double V Notch blade does the job of slicing & penetrating in hard soils, cutting straw & residue, and providing traction to keep the blades rotating. The result is a smoother furrow bottom compared to the more conventional U notch blade.

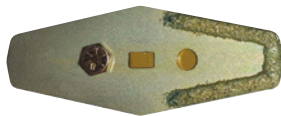

**Max Life Scrapers**

With up to 10 times longer wear than standard scrapers, Max Life scrapers take advantage of new hard surfacing technology. Tungsten carbide is mixed directly into the molten weld bead.

**Rubber Otico Roller**



Excellent all-around packer with a unique corrugated ridge profile, which leaves a field finish designed to manage moisture and prevent soil erosion.

**LSTXE Roller**



The Exclusive LSTXE Rubber Furrow roller includes state of the art features that excel in sandy and wet conditions.

**Other Options**



**Notched Disc**



**Smooth Disc**



**9 or 12 bar  
Cage Roller**

# PRO-TILL® | 10/13

HIGH PERFORMANCE TILLAGE



\*\*\* Ensuring the tractor's 3-point hitch can hold the pro-till is critical for safety, and will often be more limiting than the tractor's hydraulic output or horsepower rating.

**NOTE: Requires Cat 3 or Cat 4 - 3 point and good amount of front weight ballast to operate.**

## SPECIFICATIONS

Model	PT10	PT13
Working Width	10' (3m)	14' (4m)
Transport Width	11'-8"	15'-0"
Weight	See Weight Chart	See Weight Chart
Lift Weight***	See Weight Chart	See Weight Chart
Number Of Discs	24	32

## WEIGHT CHART

Model	ROLLER TYPE	ACTUAL WEIGHT (LBS)	LIFT WEIGHT (LBS)
PT10	Rubber + scrapers	5,350	9,310
	Cage roller (9-bar)	5,060	8,200
	Cage roller (12-bar)	5,250	8,820
PT13	Rubber + scrapers	7,050	12,870
	Cage roller (9-bar)	6,340	10,290
	Cage roller (12-bar)	6,580	11,100

# PRO-TILL® | 14/17/20

HIGH PERFORMANCE TILLAGE



Model	PT14NT	PT17NT
Width Available	14' (4m)	17' (5m)
Transport Width	9'-10"	9'-10"
Weight	13,160 lbs (5,970 kg)	14,740 lbs (6,685 kg)
Hitch Weight	3,505 lbs (1,590 kg)	4,315 lbs (1,957 kg)
Number of Discs (per-wing)	15	19

Model	PT20NT
Width Available	20' (6m)
Transport Width	9'-10"
Weight	16,320 lbs (7,403 kg)
Hitch Weight	5,020 lbs (2,277 kg)
Number of Discs (per-wing)	23

# PRO-TILL® | 20/26

HIGH PERFORMANCE TILLAGE



Model	PT20	PT26
Width Available	20' (6 m)	26' (8 m)
Transport Width	13'-10"	13'-10"
Weight (including gauge wheels)	20,080 lbs (9,110 kg)	23,480 lbs (10,650 kg)
Hitch Weight	5,200 lbs (2,360 kg)	6,510 lbs (2,952 kg)
Number of Discs(per-wing)	23	31



# PRO-TILL® | 40

HIGH PERFORMANCE TILLAGE



## The Original Monster Featuring Hybrid True Greaseless Technology

With the Pro-Till 40 foot machine, Degelman Industries pioneered the trend of a “North American High Performance Disc”. We took European technology and added weight where it was needed, simplicity where it made sense, and performance where it mattered, so it could withstand the acres and punishment that farmers across North America demand. There is still nothing heavier and better built on the market. The Pro-Till 40 is undeniably Degelman.

### SPECIFICATIONS

Model	PT40
Width Available	40' (12 m)
Transport Width	20' (6m)
Weight	34,560 lbs (15,680 kg)
Hitch Weight	8,500 lbs (3,855 kg)
Number of Discs (center)	32
Number of Discs (per-wing)	31

# PRO-TILL® | 30/36/41/45

HIGH PERFORMANCE TILLAGE



## Next Generation, High Performance Tillage

Featuring a narrower transport size, True Greaseless Technology throughout the entire machine, and added versatility with the optional Pro-Cast Precision Granular applicators.

The Pro-Till High Speed, High Performance Disc gets you in the field fast, and allows you to get your work done quickly and efficiently.

### SPECIFICATIONS

Model	PTL30	PTL36
Transport Height (Low c/w Rubber Roller)	13'-0"	13'-5"
Transport Width (Low Position)	14'-8"	14'-8"
Weight (c/w rubber roller, scraper & 20" discs)	27,500 lbs	31,500 lbs
Hitch Weight	7,000 lbs	9,000 lbs
Number of Discs (center)	24	24
Number of Discs (per wing)	23	31

Model	PTL41	PTL45
Transport Height (Low c/w Rubber Roller)	13'-6"	13'-8"
Transport Width (Low Position)	17'-8"	17'-8"
Weight (c/w rubber roller, scraper & 20" discs)	37,800lbs	39,500lbs
Hitch Weight	10,500 lbs	11,400 lbs
Number of Discs (center)	32	32
Number of Discs (per wing)	33	37



## High Performance Ripping

Introducing the all new HDSR line of Heavy Duty Staggered Rippers from Degelman. When your operation needs something more than conventional tillage, look no further. **The HDSR offers aggressive, industry leading 24" maximum ripping depth.** With the under frame clearance of 44", there's plenty of room for crop residue and rocks to pass through the machine, and makes changing points easier and safer.



Scan for more info



## Heavy Duty Frame

As with all of our equipment, the frame is heavy duty and engineered tough. We built the frame to penetrate even the hardest, most compacted dirt. There's no need to wait for rain or turn on the irrigation to get your ripper in the ground.

## True Greaseless Technology

We built the HDSR with the same greaseless technology that goes into our other equipment. The oversized electroless plated nickel pins are used on all of our high wear parts, making this a 95% greaseless machine.

## Simple & Effective Depth Control

Depth change is as easy as adding shims to the wheel cylinders, conveniently located at the front of the machine. The ripper levels itself automatically so no hitch level adjustment is necessary, unlike the competitors. We know every minute of downtime on your operation matters.

## Narrow Transport

With a narrow transport width of just 11 feet 11 inches, and a short transport height of under 12 feet, you can quickly fold it up and get to the next field. When you add the chopper rollers, the height increases slightly to 14 feet 1 inch, but can help chop up the large particles for a finer field finish.



## Under Frame Clearance of 44"

That gives plenty of room for crop residue and rocks to pass through the machine. It also makes changing points easier and safer.



## Optional Chopper Roller

The optional rear chopper roller effectively crumbles any clumps pulled up by the ripper shanks. Available with standard spring pressure or hydraulic down pressure for extreme conditions

## Optional Coultter Discs

We offer 20" coultter discs that cut surface residue ahead of the shank and reduce implement draft. The coultter disc arms utilize the proven Degelman rubber torsion suspension system which provides a maintenance free and spring free coultter trip design. The coultter mount also casters for corners to reduce mechanical stress.



## Auto Leveling System

The ripper levels itself automatically so no hitch level adjustment is necessary and you can easily change ripping depth without having to exit the tractor and manually crank a turnbuckle to re-level the machine.

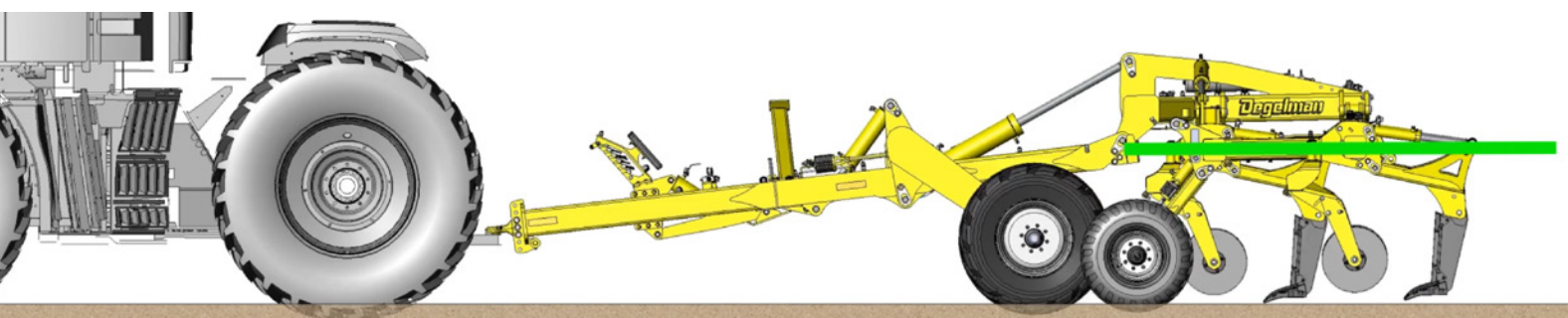

## TRIP OPTIONS



### Hydraulic Trip

Available for the most punishing conditions of hard soil and numerous rocks.

Trip Force/Point Load: 3000-5000 lbs



### Auto-Reset Spring Trip

Standard option and is suited for fields with loose soil and many rocks.

Trip Force/Point Load: 2800 lbs



### Shear Bolt Trip

Optional for producers with loose, sandy soil and few rocks.

Trip Force/Point Load: 9000 lbs

## SHANK OPTIONS

### 3/4" Thick Min-Till Shank

Offers an undisturbed surface while effectively shattering subsoil compaction.



### 1-1/4" Thick Straight Shank

Minimum residue disturbance with excellent subsoil tillage.

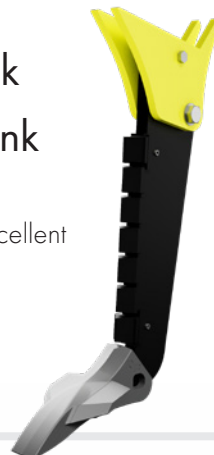

### 1-1/4" Thick Parabolic Shank

This shank was designed with aggressive tillage in mind.

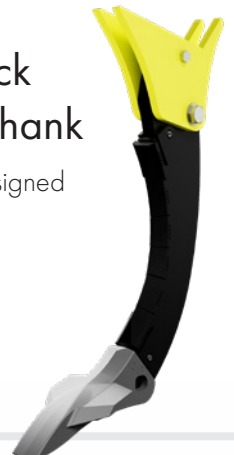

## POINT OPTIONS

Results show during in-field testing and in DEM (discrete element method) simulations that the point has a big effect on surface disturbance and field finish. Larger winged ripper points result in better compaction shattering ability while narrow ripper points result in a better minimum tillage field finish. Proper shank and point selection is key for the results you want to see at your farm.

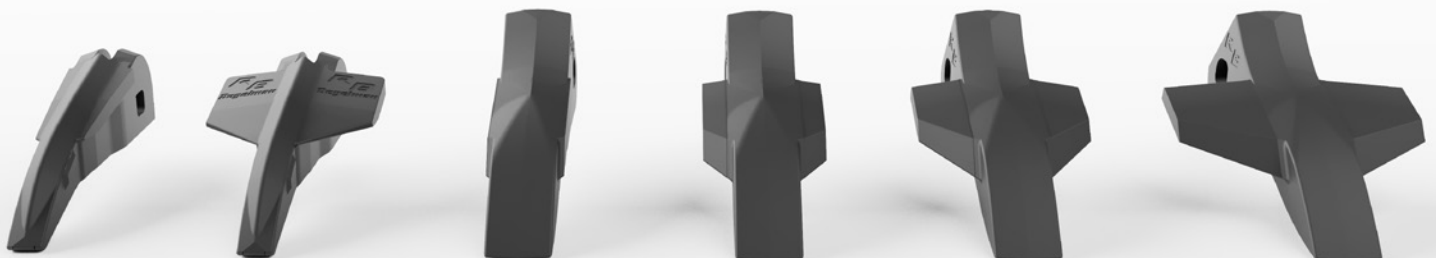

For the 3/4" shanks, we offer 2" Narrow Points and 7" Winged Points for a min-till field finish.

For the thicker 1.25" shank we offer a variety of points ranging from 3" Wingless Points to 10" Winged Points.

## Drop The Pin and Go

The HDSR Series offers minimal maintenance with few connections to grease. The wing hinges and cylinders move with less frequency and therefore have a greased pin that will likely only have to be greased a couple times a season.

True Greaseless Technology is featured on high wear parts where it matters most such as the rock shaft, auto-level, gauge wheels, and chopper roller arms.



## The Benefits of a Staggered Ripper

The Staggered two row layout provides better trash flow and lower draft than an in-line ripper. It also allows for shorter implement contour length, easier transport, and better compaction shattering ability than a V-ripper.



Model	HDSR 930	HDSR 1320	HDSR 1130	HDSR 1520
Working Width	22'-6"	21'-8"	27'-6"	25'-0"
Transport Height (w/o chopper)	11'-11"	11'-11"	11'-11"	11'-11"
Transport Height (with chopper)	13'- 11"	13'- 11"	14'- 1"	14'- 1"
Transport Width	11'-11"	11'-11"	11'-11"	11'-11"
Transport Length	17'-8"	17'-8"	20'-0"	20'-0"
Field Length (w/o chopper)	25'-2"	25'-2"	27'-8"	27'-8"
Field Length (with chopper)	27'-0"	27'-0"	29'-5"	29'-5"
Spring/Hydraulic Trip Height	20"	20"	20"	20"
Outside Wheel Track	10'-8"	10'-8"	10'-8"	10'-8"
Weight (w/o chopper)	18,000 lbs.	20,500lbs.	20,000 lbs.	22,500 lbs.
Weight (with chopper)	20,300 lbs.	22,800 lbs.	22,500 lbs.	25,000 lbs.
Hitch Weight (w/o chopper)	2,800 lbs.	3,200 lbs.	4,000 lbs.	4,600 lbs.
Hitch Weight (with chopper)	3,200 lbs.	3,600 lbs.	4,600 lbs.	5,100lbs.
Number of Shanks	9	13	11	15
Shank Spacing	30"	20"	30"	20"
Optional Chopper Size	17" Diameter X 10'-9" LG		17" Diameter X 12' LG	
Standard Equipment	Auto-Level Technology, Hydraulic Park Jack, Safety Lights, Hose/Manual Holder, Compaction Depth Probe			
Shank Construction	AR400 Steel			
Tire Size Center	500/60R22.5			
Tire Size Wing	400/60R15.5			

# PRO-CAST

## Precision Granular Applicator

Introducing the Degelman Pro-Cast, precision granular applicator designed specifically for Degelman Pro-Till High Performance Discs and Strawmaster Series of heavy harrows.

Whether you're seeding or applying herbicides, Degelman Pro-Cast is designed to deliver an accurate spread of product in all kinds of field conditions. Pro-Cast includes state of the art features including a Non-Pressurized tank, ISOBUS controls and a simple, accurate metering system that is designed to make granular application, and cover crop seeding safer and more efficient than ever.

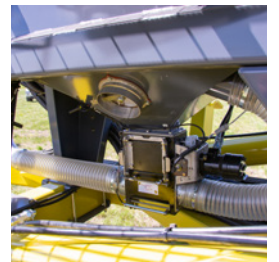

80



## Tank Features

- Concealed platform and ladder
- Plastic fan housing
- Thread on lid
- Bulk bag support frame
- Access gate to empty tank
- Sloped sheets ensure complete clean out
- Steel tank



## Metering System

- Simple calibration
- High accuracy
- Easy to adjust metering wheels
- Polyurethane housing
- Stainless steel components
- ISOBUS interface

## SPECIFICATIONS

Model	PC80
Capacity	80 FT <sup>3</sup> /65 Bushels
Max. Application Rate	200 lbs/acre @ 10 MPH (40 ft Pro-Till)



## Optional Features

- Tank level indicator
- Calibration door indicator
- Cab monitor
- Equipment harness
- Metering control switch
- Bulk bag support frame (optional)

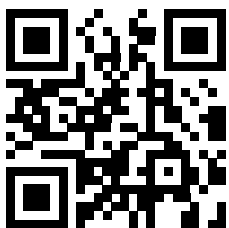

Scan for more info



Seeds are fed from the seed tank via the electrically controlled seeding shaft into the air duct. Here, the seeds are conveyed by air support through plastic hoses to the dispersion plates, and then evenly distributed close to the soil. This process allows for precise seeding even in windy conditions.

**Versatile Tank Design**

- Easy filling - large hopper opening for big bag filling
- Reversible hopper cover

**High Performance Chemical & Seed Incorporation**

The Pro-Cast 28 is a high performance tool that excels in seeding cover crops or pasture, such as grass, alfalfa or hay. In addition to cover crops, large seed and small seed blends can be planted, including annual ryegrass, cereal rye and wheat. Compatible with the 20 and 26 ft Pro-Till high performance tillage tool, the Pro-Cast 28 offers a 28.2 cu ft/22.7 bushel hopper volume.



**SPECIFICATIONS**

Model	PC28
Capacity	28.2 cu ft/22.7 bushel hopper volume
Max Application Rate	168 lbs/acre @ 10 mph (20 ft Pro-Till)
Working Width	9 - 39.4 ft with electric fan, 16 outlets
Dimensions	49.2" H x 39.4" W x 67" D
Unit Includes	Tank, Screen, 2 Seed Rollers (Fine Blind & Coarse), Cab Monitor, Cable Extensions & 600FT of Granular Hose

**SCORPION HITCH**

The Degelman Pro-Till already offers one of the most versatile discs in the industry. Add one more thing to the list of things you can accomplish with your Pro-Till 40. With the Scorpion High Speed Applicator Hitch, you can put down seed, work in fertilizer or do both at the same time.

In ideal conditions, an air drill or planter is still going to be the first choice for many growers, but for wet seasons where getting your seed in the ground in adverse conditions and in a short window is proving challenging, the Scorpion Hitch for Pro-Till makes a great back-up plan.



# HEAVY HARROWS

## High Performance Harrow

Degelman Industries pioneered the heavy harrow over 30 years ago, and hasn't looked back since. If you're looking to tackle enormous straw problems, the Degelman Strawmaster line of heavy harrows is what you're looking for. Our impressive line of Strawmaster heavy harrows come equipped with the exclusive, game changing, carbide Endura-Tip tines, which significantly increase the life and performance of your Degelman Strawmaster.



**Tungsten Carbide.  
Consistent Field Finish.**

**Enhanced Control.  
Best Overall Value.**

Degelman's tungsten carbide Endura-Tip is exclusive to Degelman Strawmasters. Significantly increasing the life and performance of your harrow bar, the tungsten carbide tipped harrow tines maintain their original length and shape, resulting in enhanced control and a more consistent field finish.



## Tungsten Carbide

Simply the best tines available on the market today. At 1.5 times the hardness of titanium, our tungsten carbide tine tips are proven to last 8 – 10 times longer than our competitors.

## Cutting Edge

The sharp corners of the square tungsten carbide tip act as cutting edges, chopping and mixing at a far superior rate than that of traditional round tine tips.

## 26" or 30" of Vibration

Perfectly engineered for movement. Creating the maximum amount of mixture, leaving a fine, flawless seedbed.



\*Strawmaster Pro tine measuring 30" after 100,000+ acres



# STRAWMASTER



## Breaking & Spreading Straw

The primary purpose of the Strawmaster is to break up and spread most types of straw residue efficiently. High frequency vibration provides the shattering action for perfect residue control. For most farming practices, speeds of up to 12 mph can be attained.

## Patented Torsion Technology

At the heart of all Strawmaster harrows is Degelman's often imitated, never duplicated, torsion technology. Simply rotate the 8" x 8" beam hydraulically and apply more pressure through the spring bars. This gives you the control and flexibility to make the Strawmaster work the way you want it to.

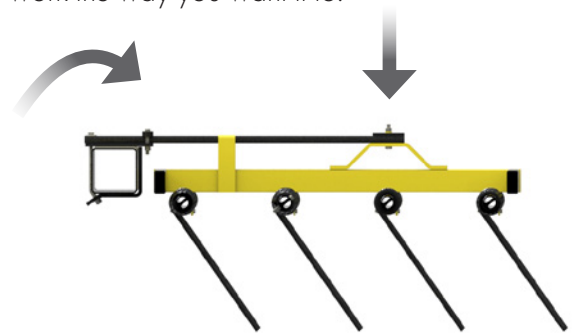

The Degelman Strawmaster® is the revolutionary machine designed to tackle enormous straw problems. We pioneered the simple torsional spring bar design which offers performance unlike other heavy harrows. With 26 inch long tines equipped with tungsten carbide tips placed in five or seven rows, this machine is at the forefront of modern straw management. The Strawmaster® will shatter straw, control weeds, rake flax straw, and incorporate seed and chemicals.

## SPECIFICATIONS

5 Row Model	SM50	SM70	SM82
Widths Available	50'	70'	82'
Weight	11,360 lbs	13,940 lbs	15,238 lbs
Horsepower (min)	150	200	300
Horsepower (ideal)	200	300	350
Transport Length	42'	52'	58'
Harrow Sections	5	7	9
Transport Hitch Weight	0	-155 lbs (upwards)	-330 lbs (upwards)
Transport Width	14' - 7"	14' - 7"	14' - 7"
Transport Height	10' - 6"	10' - 6"	10' - 6"
Tine Spacing	18" Centers	18" Centers	18" Centers

7 Row Model	SM50	SM70	SM82
Widths Available	50'	70'	82'
Weight	11,700 lbs	16,080 lbs	18,400 lbs
Horsepower (min)	285	400	475
Horsepower (ideal)	325	450	525
Transport Length	42'	52'	58'
Harrow Sections	5	7	9
Transport Hitch Weight	N/A	-300 lbs (upwards)	-600 lbs (upwards)
Transport Width	14' - 7"	14' - 7"	14' - 7"
Transport Height	11' - 6"	11' - 6"	11' - 6"
Rows of Tines	7	7	7
Tine Spacing	14" Centers	14" Centers	14" Centers

## Available in 5 & 7 row configurations

**5 Row**

5/8" x 26" tines

**7 Row**

1/2" x 26" tines

Equipping the Strawmaster with 7 rows gives you approximately 68% more ground coverage in the field.

# STRAWMASTER +



The All New Strawmaster + was designed from the ground up to provide the ultimate field finish. Available in 4, 5 and 7 row configurations, the Strawmaster + can be customized to match your specific needs. At the heart of the machine are the robust 10x10 wing beams. These provide consistent beam torque throughout the machine, and help spread straw evenly for a more consistent finish. Add up all of these great features: Carbide Endura Tips Tines + True Greaseless Technology + mirrored tine rephasing cylinders for increased tine angle power + reduced transport width + multiple setting indicators + large flotation tires - and you'll understand why it's called Strawmaster +.



## Narrow Transport Width

The Strawmaster + has a narrower transport width than our previous Strawmaster series - coming in at 12' 6". The inboard transport/wing wheel assembly allows for the machine to follow the tractor more closely, making it easier to get in and out of narrow trails into the field.



## Available in 4 row, 5 row, and 7 row configurations

### 4 Row

5/8" x 30"  
tines

### 5 Row

5/8" x 26"  
tines

### 7 Row

1/2" x 26"  
tines



## SPECIFICATIONS

Model	SM+   70	SM+   90
Width	70'	90'
Weight	18,720 lbs (4 row) 19,340 lbs (5 row) 20,860 lbs (7 row)	23,770 lbs (4 row) 22,340 lbs (5 row) 23,770 lbs (7 row)
Horsepower(min)	400	500
Horsepower(ideal)	450	550
Transport length	55'	65'
Harrow sections	7	9
Hitch weight	+280 lbs (min)	+110 lbs (min)
Transport width	12'-6"	12'-6"
Transport height	13'-6"	13'-6"
Rows of tines	4, 5, 7	4, 5, 7

\*For more detailed specs and sizes, visit [www.degelman.com](http://www.degelman.com)



## Robust Wing Beams

At the heart of the machine are the robust 10x10 wing beams. These provide consistent beam torque and tine pressure throughout the machine, and help spread straw evenly for a more consistent field finish.



## Customized Field Finish

There are three setting indicators on the Strawmaster + that are all easily visible from within the cab. One for cart height, one for beam torsion and one for tine angle. Knowing exactly how your machine is running is key when getting your desired field finish.



## Increased Power for Tine Angle

Our re-configured cylinder set up gives you increased power for tine angle. When conditions are tough, have the confidence knowing that the Strawmaster + will have the power to manage and spread the straw as you need.

# STRAWMASTER X



## Simple Disc Harrow Design

After years of testing we have found that one row of 20" discs at 10" spacing combined with 4 bar harrow sections equipped with 30" tines (that's the same as our Strawmaster Pro) resists plugging in wet conditions and allows material to flow through the machine more freely.



The Strawmaster X Disc Harrow, with disc on command technology gives you the ability to cover large acres at high speeds in a large working width. Built off the impressive Strawmaster+ frame, the design allows for more tillage than a traditional heavy harrow, but less aggressive than a high speed disc. The Strawmaster X will size residue, while still leaving some standing material to catch snow.

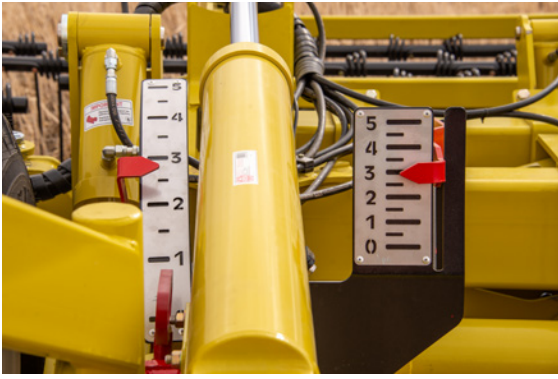

## Setting Indicators

There are four setting indicators on the Strawmaster X that are all easily visible from within the cab. One for cart height, one for beam torsion, one for tine angle, and one for disc depth. Knowing exactly how your machine is running is key when getting your desired field finish.



## Disc Angle Adjustments

Having the option to change the disc angle allows you to use the machine in various conditions.

- 0-4 degrees with a coultter disc will allow you to open the ground and cut trash with minimal soil disruption.
- 5-7 degrees is good for mixing some dirt with residue while loosening the soil but still leave stubble standing to catch snow.
- 8-10 degrees is perfect for working low spots with high trash.



The Strawmaster X transport width of 12' 6" and height of 13' 6" makes getting down grid roads safer and easier. The unique end wheel design follows the tractor better than traditional harrows, making it easier to turn into more narrow approaches.

## Discs On Command

Adjustable angle of 0-14 degrees on the discs give you the ability to blacken the soil which warms up the field quicker in spring for seeding, speeds up drying in wetter years and allows material to break down over winter. In drier years, lift the discs out of the way and use as a traditional 4 bar harrow.



## SPECIFICATIONS

Model	SMX50	SMX70
Width	50'	70'
Weight	27,300 lbs	35,640 lbs
Horsepower(min)	400	500
Horsepower(ideal)	450	550
Transport length	42'3"	55'
Harrow sections	5	7
Hitch weight	-650 lbs	-790 lbs
Transport width	13'0"	12'6"
Transport height	13'6"	13'6"
Rows of tines	4	4
Disc Spacing	10"	10"
Disc Size	20"	20"
Disc Angle	0° - 14° variable	0° - 14° variable

# STRAWMASTER PRO

HIGH PRODUCTION FIELD CONDITIONER



In today's farming, time is precious. We have lots of land to cover, with a relatively short growing season. Our leading farmers have been waiting for a tool to help warm the soil and promote effective seed germination. Available in sizes up to 120 feet, The Strawmaster Pro, equipped with our exclusive 30" tungsten carbide Endura-Tip tines, offers incredible tine penetration. This not only rakes straw, but moves ground, blackening up the field and stimulating plant growth when it's most critical. The Strawmaster Pro is a lot more than a big harrow.



## SPECIFICATIONS

Model	SMP100	SMP120
Widths Available	100'	120'
Weight	45,900 lbs	48,300 lbs
Horsepower (min)	450 hp	560 hp
Horsepower (ideal)	550 hp	620+ hp
Transport Hitch Weight	3,780	3,750
Transport Length	74'-8"	84'-2"
Harrow Sections	10	12
Transport Width	18'	18'
Transport Height	12'	12'
Rows of Tines	4	4
Tine Spacing	24" Centers	24" Centers

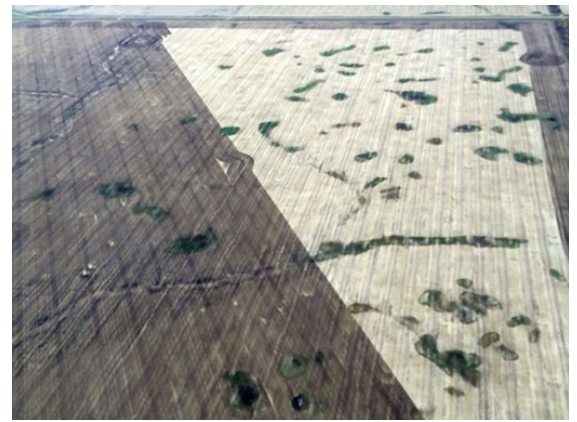

## Harrowing Becomes Light Tillage

The Degelman Strawmaster Pro is revolutionary; designed for both straw management or light tillage applications. When you combine the extraordinary weight of the machine with 30" long tines placed in 4 rows, this machine is beyond any other harrow bar. The Strawmaster Pro will shatter straw, control weeds, rake flax straw, and incorporate seed and chemicals or act as light tillage.

## Degelman Hydralink Technology

Our break-through Hydralink technology is the key feature that allows for frame flexibility, field contouring and the ability to sink the tines into the ground to provide for light tillage. The Strawmaster PRO not only transfers the machine weight to each tine, but it does so in hilly conditions. In float position or under pressure, the harrow sections are designed for flexibility.



# LANDROLLER

## Flattens The Ground - Pounds The Stones In

Available in sizes from 20 to 80 feet, a Degelman Land Roller provides excellent packing pressure and smooth operating which offers combine protection by flattening the fields and pounding the stones in. This makes it possible to harvest peas, lentils, and beans quickly and efficiently. The LR Series offers a 36" drum and the Hy-Roller series offers both 36" and 42".



## True Drum Overlap

Drum overlap has to be done right. Competitors will try to disguise overlap with small secondary drums causing unequal pressure, unnecessary complexity, and moving parts and bearings. Degelman drum overlap is simple and built into one heavy design.

## Diameter vs PSI Comparison

A smaller diameter 36" drum, since it has less surface area, will provide more downward packing pressure per foot. In areas that are traditionally more minimum till to no-till, this extra packing pressure will handle stones and level the field more consistently. For areas that are more aggressively tilled, and hay land, a 42" provides less packing pressure per foot, but makes up for it with a heavier drum.

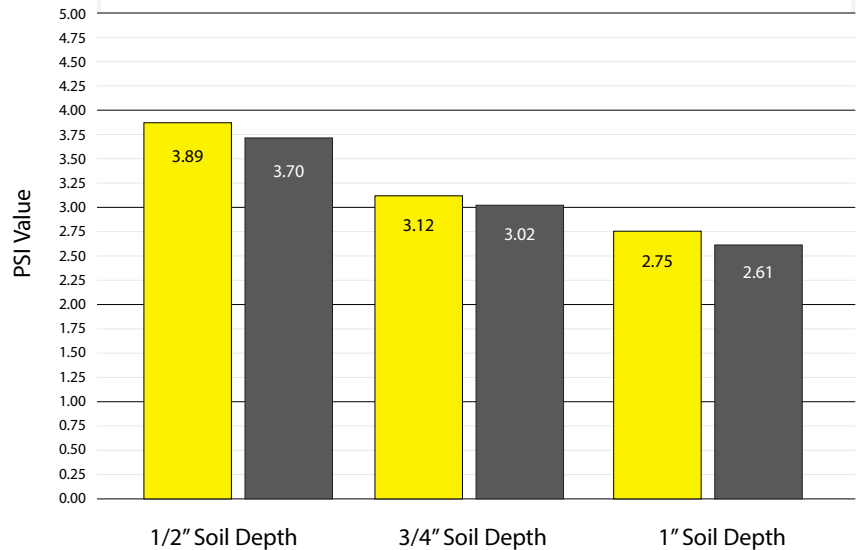

36" Diameter

42" Diameter



Scan for more info

## FIVE-PLEX 64/80



Available in 64 feet and 80 feet models, these units are extreme duty. These five-plex rollers contour like never before, allowing you to cover a lot of ground, worry-free. Degelman landrollers are some of the heaviest, most reliable available. Ideally used for peas, beans and lentils, they also prepare the perfect bed for haying, grasses and silage.

## TRI-PLEX 34/45/51



Degelman landrollers not only decrease downtime and fuel costs, they also provide optimal seed to soil contact while reducing weeds and moisture loss. Level land allows cutter bars to safely access the base of plants without the risk of rock ingestion. This allows for a faster, safer and easier harvest which ultimately translates to a increased yield on pulse crops such as beans and cereals. The newly designed HAMEC end wheels (45/51 models) make unfolding the landroller easier than ever.

## SINGLE DRUM ROLLER



This landroller was specially designed for specialty crop producers who find our standard rollers too large for their farming operation. With hydraulic fold capabilities, it easily transforms to a narrow 8' transport width, making this machine safe and simple to transport. It's 36" diameter drum incorporates the same heavy duty features as our Tri-Plex rollers such as heavy duty cylinders, oversized shafts and long life bearings.

## SPECIFICATIONS

Model	Single Drum		3-Plex		5-Plex	
	LR2036	LR7634	LR7645	LR7651	LR8064	LR8080
Segments	1	3	3	3	5	5
Drum Width Configuration	20'	11'-6"   11'-6"   11'-6"	17'   11'-6"   17'	20'   11'-6"   20'	13'   13'   15'   13'   13'	17'   17'   15'   17'   17'
Working Width	20'	34'	45'	51'	64'	80'
Drum Diameter	36"	36"	36"	36"	36"	36"
Drum Overlap	N/A	4-3/8"	4-3/8"	4-3/8"	6" & 11-1/2"	6" & 11-1/2"
Transport Length	25'-10"	36'-6"	42'	45'	51'-6"	59'-5"
Transport Width	8'	16'	16'	16'	16'	16'
Transport Height	5'-2"	5'-2"	5'-2"	5'-2"	6'-10"	6'-10"
Working Weight	7,840 lbs	12,195 lbs	16,733 lbs	18,007 lbs	28,673 lbs	33,202 lbs
Weight Per Ft	392 lbs	359 lbs	372 lbs	353 lbs	448 lbs	415 lbs
Transport Hitch Weight	555 lbs		475 lbs	275 lbs	750 lbs	575 lbs
Autofold (transport to field)	Hydraulic	Back Up	Back Up HAMEC Assist	Back Up HAMEC Assist	Back Up with Hydraulic Assist	Back Up with Hydraulic Assist
Autofold (field to transport)	Hydraulic	Drive Forward	Drive Forward	Drive Forward	Drive Forward	Drive Forward

# HY-ROLLER



With a new Narrow Transport folding system, the Hy-Roller offers the choice of either 36" or 42" drums to fit your farming operation. The Degelman Hy-Roller is simple, robust, and designed with a "Drop the Pin and Go" mentality. True Greaseless Technology will get you in the field earlier and keep you there longer."

## Quick Fold - Narrow Transport System

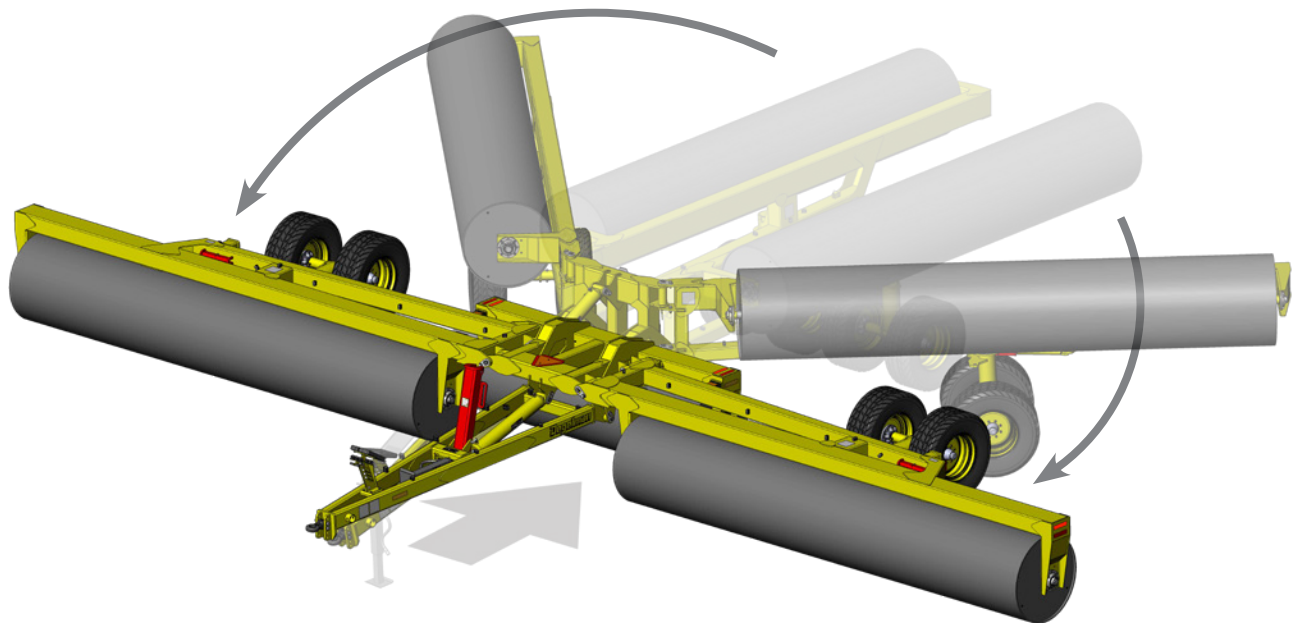

Quick fold/unfold operation while backing up (achieved within length of machine).





# ROCK REMOVAL

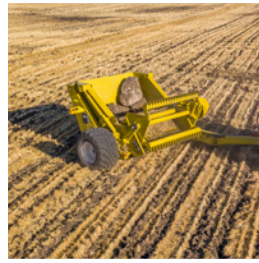

Providing Relentless  
Stone Work  
For 60 Years

Degelman Industries offers an entire line of rock removal equipment that is designed to not only provide relentless heavy stone work day in and day out, but also clear your fields to make seeding and harvest time faster and more efficient.

## Super Picker III



The legend returns. The original Super Picker was designed for farmers with serious rock problems on their farm. Taking what we've learned from over 60 years of rock picker design and manufacturing, we are excited to introduce the sequel you've been waiting for – Super Picker III.

With a 6'-6" working width and a 7' 3" dump height, you'll pick more rocks for longer periods with less trips to the rock pile.



### Large Bucket Capacity

Your time is valuable. With a 3.75 cubic yard bucket, Super Picker III lets you spend less time at the rock pile and more time at the windrow or in the field.

### Huge Flotation Tires

You asked, we listened. The Super Picker features an industry leading 600/50R22.5 BKT FL630 ULTRA set of tires for superb flotation in the field.

### SPECIFICATIONS

Model	SP7800
Working Width	16'-4"
Grill Width	6'-6"
Transport Width	13'
Horsepower (min)	150 hp
Hopper Capacity	3.75 yd <sup>3</sup>
Weight	10,580 lbs
Hitch Weight	1,040 lbs
Height - Empty	8'-2"
Height - Unloading	7'-3"
Drive	Hydraulic



**signature** ROCK PICKER  
*W. J. Degelman*



The Degelman Signature series rock pickers are the result of almost 60 years of pursuing excellence. Degelman Signature Series are unrivaled for performance and durability. Featuring superior rock and soil separation, a heavy reel spring design and a robust frame. Our attention to detail means these machines will work flawlessly for years to come, as you will commonly find Degelman rock pickers made decades ago still working today. Our standard hydraulic long hitch pole is allowed to pivot, providing a large working envelope, superb visibility for picking rocks and the ability to tuck the picker behind the tractor for narrow transport.

### Spring Styles



6000 Series  
Tension Spring



7200 Series  
Compression Spring

### Options

#### Extra Long Hitch Pole

The extra long hitch pole option is a 180" pole that is useful for tractors with larger tires and fenders.



#### Large High Flotation Tires

These large diameter 550/45 - 22.5 tires disperse the weight of rocks in the hopper and minimize the pounds per square foot. This can reduce the possibility of heavy rutting.



### SPECIFICATIONS

Model	Signature 6000	Signature 7200
Working Width	11'-6"	13'-11"
Grill Width	5'	6'
Transport Width	9'-7"	10'-10"
Horsepower	70-150 hp	70-180 hp
Hopper Capacity	2 yd <sup>3</sup>	3 yd <sup>3</sup>
Weight	4,700 lbs	6,350 lbs
Hitch Weight	750 lbs	850 lbs
Reel Spring	Tension	Compression
Length		14'-16'
Height - Empty		6'-4"
Height - Unloading		3'

# ROCK KING 9600



The King is here. Degelman introduces its largest rock picker ever. With an incredible 8' wide grate, 5 cubic yard bucket and 7'3" dump height, the Degelman Rock King is simply second to none. With 30 inches of clearance between the paddle assembly and the grill, large stones are easily picked. These machines are designed to provide relentless heavy stone work day in and day out.

## Huge Bucket Capacity

With a 5 cubic yard bucket and an 8' wide grate, Degelman Rock King lets you spend less time at the rock pile and more time at picking.



## Round Solid Steel Grill

The grill teeth on the Rock King are made of round solid 2" diameter C1045 steel shafts. This steel is much stronger than ordinary mild steel and has a natural spring to it to resist impact damage. A Degelman grill is extra heavy, developed with the optimum sweeps and curves to separate rocks from dirt. Every third tooth is welded to the frame to allow small lodged rocks to clear freely. The round profile itself is also the optimum shape with the smallest choke point to minimize jams.

## High Dump

Keep your rock pile tidy. The Rock King's imposing 7' 3" dump height lets you pile higher than ever before.



## Precision Grill Control

The wheel placement created between the tractor hitch and the offset tires provides precise reactive control over grill depth, exceptionally important when working in soft and/or wet field conditions.



## SPECIFICATIONS

Model	RK9600
Working Width	18'-6"
Grill Width	8'
Transport Width	15'-6"
Horsepower (min)	200 hp
Hopper Capacity	5 yd <sup>3</sup>
Weight	15,300 lbs
Hitch Weight	1,520 lbs
Length	23'-6"
Height - Empty	8'-4"
Height - Unloading	7'-3"
Drive	Hydraulic

## ***rock rake***



## SPECIFICATIONS

Model	RR1500
Width	14'
Length	17'-10"
Transport Width	7'-4"
Transport Length	18'-10"
Weight	3,640 lbs
Hitch Weight	475 lbs
Horsepower (min)	75 hp

## Windrowing Rock

The 14' wide spiral drum rakes a large swath of rocks from the field with each pass, yet the entire machine folds into a 7-1/2' narrow transport width with 10" of ground clearance.

## ***rock digger***



## SPECIFICATIONS

Model	RD320
Width	8'-6"
Transport Length	13'-5"
Weight	2,400 lbs
Hitch Weight	240 lbs
Digging Depth	32"
Horsepower (max)	250 hp

## Hard Surfaced Digging Teeth

The Degelman RD320 is a trouble-free and versatile machine that has been used for years by professional landscapers, contractors and farmers. The RD320 is designed to dig out submerged rocks and grab, lift, and transport boulders.

## ***prong picker***



## SPECIFICATIONS

Model	R570P
Width	10'-5"
Length	14'-6'
Transport Width	8'-9"
Weight	2,580 lbs
Hitch Weight	300 lbs
Horsepower (min)	75 hp

## Clear Big Stones

The R570P Prong Rock Picker has tremendous strength for a small machine. This fork-type rock picker is ideal for picking anything from a two pound stone to a 3000 pound boulder.

# BULLDOZER BLADES

## Engineered Tough with an Intelligent Design

No two tractor manufacturers are alike, so we don't develop a blade that is "one size fits all." Degelman engineers, designs and individually builds all Bulldozer Tractor fit-ups to ensure proper mounting locations are the best spot to push from - protecting your tractor investment. Featuring a precision machined tubing finish,

superior seals and high grade wear bands, the Degelman series of bulldozer blades adds value and versatility to your tractor.

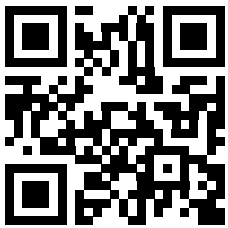

Scan for more info



## Find the Blade Series that's Right for You

Degelman Industries has been engineering tough, high performance equipment for over 60 years. The result is outstanding equipment that exceeds expectations and outperforms. We achieve this through meticulous design and vigilant customer service.



### 3500 Series

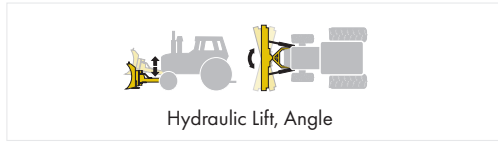
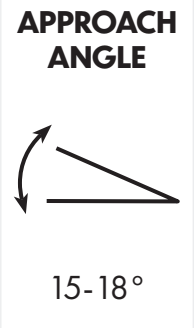
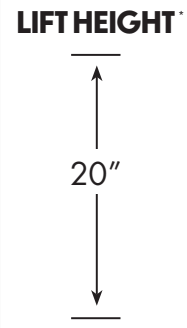
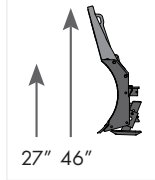

### 4600/5700 Series

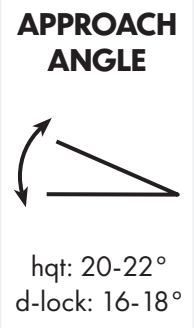
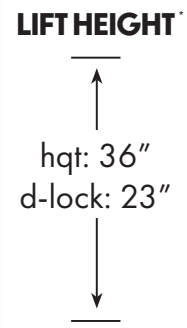
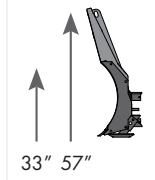

### 5900 Series

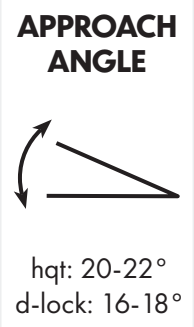
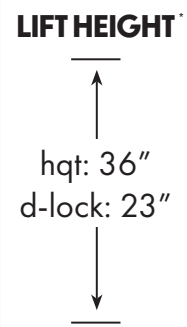
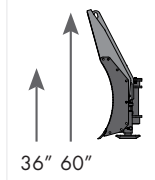

### 66/69/7200 Series

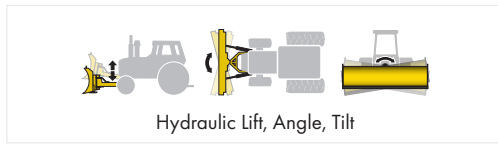
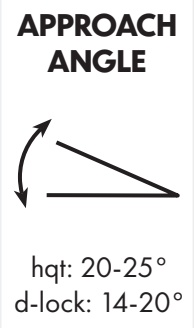
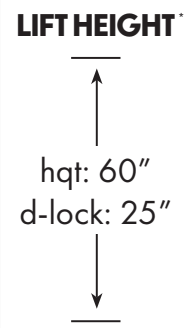
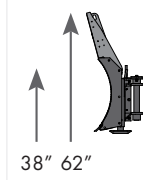

### 7900 Series

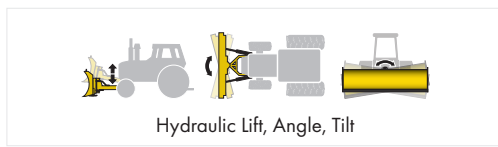
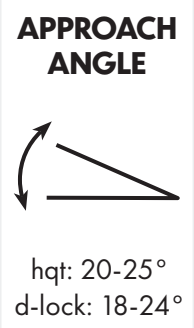
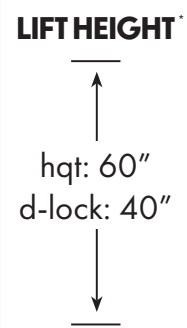
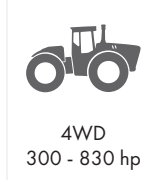
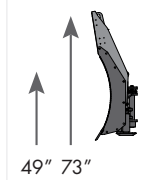

\* Lift heights vary depending on fit-up and tire size.

# SILAGE KING

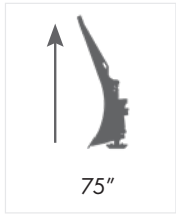

## LIFT HEIGHT\*

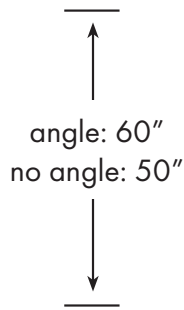

## APPROACH ANGLE

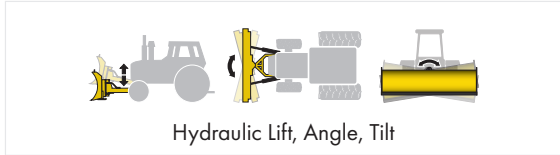
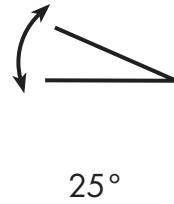

## It's Good to be King

The Silage King is built on the same rock-solid foundation that Degelman is known for, and includes features that will significantly improve how you push silage. With our new streamlined design, this blade pushes silage with less horsepower, while maximizing the approach angle - allowing you to push the silage up where it belongs.

## Designed for Silage

The Silage King with silage extension comes in at 75" tall - the tallest dozer blade in the industry. The curvature has been slightly flattened out from the 7900 in order to prevent the blade from holding on to excess material, allowing for even distribution. With more height, and less curvature, you can push more silage with less horsepower.

## Reduced Overhang for Better Control

In order to give the operator more control, we've moved the blade 19" closer to the tractor. This reduced overhang improves control while keeping the blade at the ideal approach angle to the silage pile.

## Degelman's Radial Lift Approach

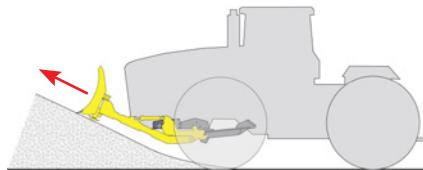

When an adjustment needs to be made by the operator, fast blade response time is necessary. The Degelman Silage King is mounted with only one pivot point, making the response time as quick as possible. This radial lift design makes it easier to push, carrying loads **UP** the pile, rather than **INTO** the pile.



## What is Quick Attach D-Block Mounting?

The D-Block® mounting system offers the convenience of quick attach/detach as well as long life. No tools are required. Fit-ups are 100% secure with zero movement. The blade can be removed in minutes by disengaging two points on the front axle brackets.

- Step 1:** Remove clip pin. Insert handle in slot 1.  
**Step 2:** Rotate to position 1 handle in slot 1.

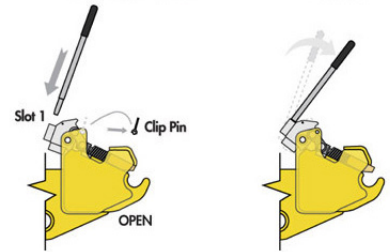

- Step 3:** Remove handle. Re-insert in slot 2.

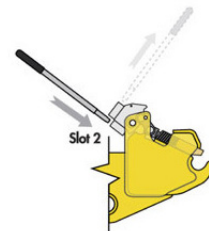

- Step 2:** Rotate to position 1 handle in slot 1.

- Step 4:** Rotate up to position 2. Remove handle & Store. Re-install clip pin.

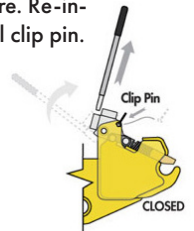

## What is HQT? (Hydraulic Quick-Tach)

In the spirit of safety and simplicity, Degelman has pushed the design process one more time by coming up with the all new HQT-Hydraulic Quick-Tach System. This precision built feature utilizes a hydraulic pin engagement concept which allows the operator to secure the blade to the Dozer mounting framework from the tractor seat. It avoids the dangers, awkwardness and hassles of crawling around the tractor to secure the dozer engagement.

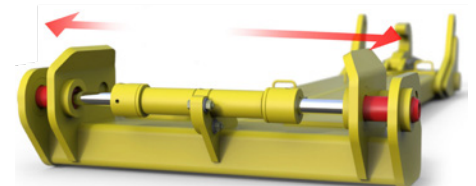



# SNOW REMOVAL

## ***strongbox***

The Degelman Strongbox is a simple, strong and effective tool for high volume snow removal. The unique design of the cone gusset provides a self-cleaning surface to prevent snow and ice from accumulating while increasing structural support to the side plates.



## ***speedblade***

Degelman's Speedblade is designed so you can hydraulically open the blade to its maximum width of 15' for small and large snow drifts or fold the wings in to move and contain high volumes of snow. And with the option to hydraulically put the wings at whatever angle you want, you can change the width as you go depending on snow fall and how much room you have to maneuver.



## **USE OUR BUILD A BLADE FEATURE TO QUICKLY FIND THE RIGHT FIT-UP FOR YOUR TRACTOR**

With over 450 different combinations of tractor manufacturers and blades available, the Degelman build-a-blade tool is an easy and efficient way to find which blade is right for your tractor. Follow the steps below to build yours today.

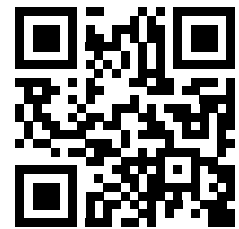

Scan to Build  
Your Blade

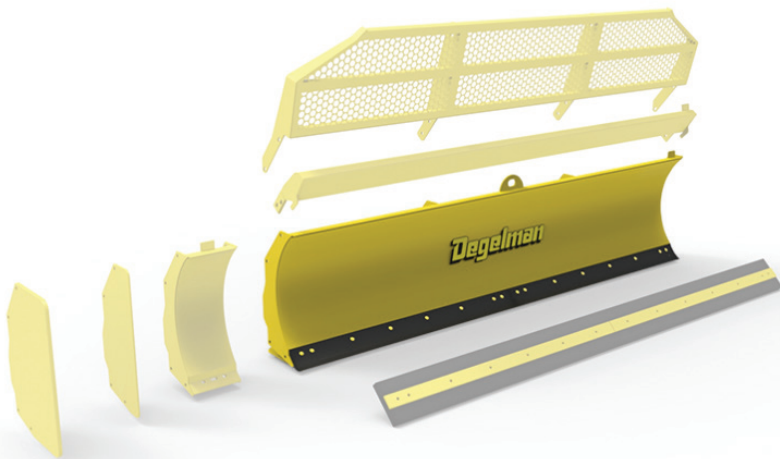

1. Visit Degelman.com
2. Click on "Build & Price"
3. Click on "Bulldozer Blades"
4. Choose your tractor
5. Select your blade
6. Choose width, options, and accessories
7. Save your build ID to view this build again
8. As you scroll, you will see mounting times, part numbers, and prices.
9. You can print, save, and email the selected blade, as well as view the total price and photos of the selected blade.

# TRUGRADE



Introducing the Degelman TruGrade, the tallest pull type bulldozer blade on the market. Our streamlined design will make cleaning ditches, grading roads, digging ditches, leveling fields, and moving snow easier and more efficient than ever.

The TruGrade design concept has a hydraulic angle capability of 37° - 40°. This allows the angle to stay the same no matter the frame offset. Our unique Continuous Angle System ensures the angle of the blade will always be the same in respect to the axle of the machine and tractor.



## Continuous Angle System

The TruGrade features a Continuous Angle System with a hydraulic angle capacity of 37 degrees to 40 degrees.

This unique feature allows the angle to stay the same no matter the frame offset and ensures the angle of the blade will always be the same in respect to the axle of the machine and tractor.

The continuous angle design ensures the angle of the blade will always be the same in respect to the axle of the machine (and tractor). This is different from a traditional pull dozer design

which always maintains the blade angle with respect to the hitch.

In that traditional design, the offset of the hitch will either add angle to or subtract angle from the blade as the blade is offset in either direction. The Degelman TruGrade can maintain its hydraulic angle of 37° -40° no matter the offset.





## TruGrade is Designed For Industry Best Capacity

- The tallest pull type bulldozer blade on the market is designed to move more material per pass
- Angle cylinders behind mouldboard avoids the mess of angle cylinders at the top of the blade and forcing angle forces to travel up through the mouldboard
- Less Structure required at top of blade and better capacity as formed mouldboard holds more material
- Square tube at top of blade disrupts flow of material and decreases effective capacity of the blade

## Reversible Cutting Edge

The Degelman TruGrade is one of the few pull type bulldozer blades to offer a reversible cutting edge

- Greatly reduces stress on bottom 1/3 of mouldboard while still providing equivalent wearable material as non-reversible
- Reversible cutting edge provides plenty of wearable material with the ability to flip once one side worn.
- This allows you to quickly and easily flip cutting edge if one side damaged, and no replacement handy
- Double break at bottom of mouldboard perfectly recesses cutting edge for smooth flow of material. Keeps material from piling on top of cutting edge.

## SPECIFICATIONS

Blade Width	12'	14'	16'
Blade Height	34"	34"	34"
Weight	6,211 lbs	6,370 lbs	6,510 lbs
Concrete Weight	8,711 lbs	8,870 lbs	9,010 lbs
Ballast Amount	2,500 lbs	2,500 lbs	2,500 lbs
Blade Clearance	30"	30"	30"
Transport Width (Narrow Transport Mode)	10' 8"	8'-0"	8'-6"
Transport Width (Field Position w Full Angle)	10' 8"	12'3"	13'10"
Transport Length	24'-1"	24'-1"	24'-1"
Hydraulic Angle	37°- 40°	37°- 40°	37°- 40°
Hydraulic Tilt	15°	15°	15°
Reversible Cutting Edge	5/8" x 6"	5/8" x 6"	5/8" x 6"
True Greaseless Technology	Standard	Standard	Standard
Flip Over End Plates	Standard	Standard	Standard



# MANURE SPREADERS

## M SERIES

How do you build the best manure spreader in the world? Start with Degelman, renowned for engineering tough, high performance equipment for over 60 years. The design is unmistakably Degelman. From the ground up, these machines have been designed with rocks in mind, from its proprietary retractable free-swing flails, super duty gearbox, smooth sidewalls and heavy-duty frame to its clean gate opening. Available in 2 sizes, the M28 and M34 manure spreaders are designed to handle anything you can load in it.



For the most part, all spreaders in the world

employ beaters made from some variation of a helical or auger shape. This rigid design is always vulnerable to rock damage and high maintenance costs. The Degelman Rock Bypass System and Hammerhead Paddles are the heart of the M series manure spreaders. Five rows of free-swing flails, not only collapse upon stone impact, but will exceed expectations for throw distance, durability and even distribution pattern.

Degelman manure spreaders cut and tear material, drop heavier crumbled material to the next lower set of paddles for final processing and discharges material over 60 feet.



## Superior Distribution Pattern

Distribution and throw distance is unrivaled with Degelman. Fine pulverized material is spread over 60 feet with secondary field passes normally not required. Hydraulic Push Off systems, however, compress manure as it is unloaded. This compression rate changes as less material is available for offloading resulting in inconsistent field distribution patterns.

Commercial operators have long known that a good chain floor drag system will spread material more evenly and is more reliable. These machines pull the material to the beaters with dual 3/4" pre-stretched 100,000+ lb breaking strength marine grade drag chain and the Degelman RBS takes care of the rest.



# MANURE SPREADERS

## BIO SPREADER

The BioSpreader 14 and 20 models bring heavy duty to the next level. Built with hardened steel to prevent sagging and deformation over extended use. The live floor has a 3/4" grade 80 chain with a higher breaking strength, and the innovative vertical beater system delivers rock-steady performance, and uniform spread.

### Key Features

- Can achieve up to 50 ft wide and 100 ft long spread pattern.
- Live floor gives the option to unload all of its material in as little as 90 seconds.
- Longer hitch allows for a tighter turning radius for better maneuverability in tight spaces.
- Thicker abrasion-resistant teeth are significantly harder than regular steel so they last longer and can be easily replaced. Unique double-shear tooth retainer (patent pending).

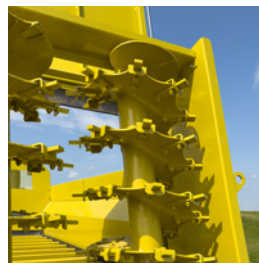

### Side Extensions

The BioSpreader has an all heavy-duty design, can be simultaneously loaded by a Track Hoe and Skid Steer, and has patented reversible/replaceable teeth, a tighter turning radius for best maneuverability, and a uniform and consistent spreading pattern.

### Innovative Vertical Beater System Delivers Rock-Steady Performance, Uniform Spread, and Easy Clean Up.

Many features on the Bio Spreader line of Manure Spreaders are a direct result of customer input: lower sides for easier loading, longer hitch for a tighter turning radius, and engineered to be towed by a smaller tractor or truck, to name a few. The biggest advances are tough, thick gauge steel construction, more reinforcement, and shock absorption for key areas like beaters and gearboxes. The beater system easily detaches so you can use the wagon on its own. It can now be used in other applications such as hauling manure to the field, snow hauling and moving other organic materials. The BioSpreader easily manages bales so you can use it to quickly spread bedding. Prototype field testing by a wide range of livestock and poultry producers, with wet and dry manure, and in extreme weather conditions, means that the BioSpreader is setting the new gold standard in manure spreading.



# CUTTING EQUIPMENT

## Rev 1500 Rotary Cutter

This is the indestructible REV 1500 rotary cutter from Degelman. The deck is made from a 3/16 inch impact resistant steel formed to create a smooth sloping deck. This curved shape deck is manufactured with continuous welds and without pockets that collect debris. As the cutter operates, debris sheds off. Maintenance is quick, easy and weeds are not transferred from one location to another.

## OnePass

The patented Degelman OnePass system reduces operating costs by mowing and applying herbicide simultaneously. A unique delivery system allows you to apply herbicide in sensitive areas without running the risk of airborne drift or contamination.



## Sidearm

With the Degelman Sidearm®, an operator can cut where it's never been possible to cut before - safely.

The operator can stay on the highway and position the cutter 50 degrees on either side of the road. Cut from the right, the left or straight back.



Scan for more info



# CONTACT US

We believe that offering a high quality product is only part of the equation and that the secret to success is an unwavering commitment to customer service. Our customers are the driving force behind everything that we do, from providing outstanding follow-up support and service, to building a reliable dealer network. We understand the value of customer trust, and we strive to earn and maintain that trust with each and every customer.



## Degelman Industries LP

### Main Office

272 Industrial Drive  
Regina, Saskatchewan  
S4P 3B1 Canada

Ph: 306-543-4447  
Tel: 800-667-3545

[info@degelman.com](mailto:info@degelman.com)

### Customer Service Center

24 Cassie Bay  
Regina, Saskatchewan  
Canada S0G 5K0



## Degelman Industries USA Ltd.

105 Boeddeker Dr. South  
Hillsboro, North Dakota 58045 USA

Tel: 701-636-1876  
Fax: 701-636-1877

[USA@degelman.com](mailto:USA@degelman.com)

## Start Your Career With Degelman

Degelman Industries is a well-established company, with deep roots in the agricultural industry for over 60 years. With locations in both Canada and the US, we are constantly looking for talented, motivated people to join our growing team. If you or someone you know is interested in joining our growing team, all our job openings can be viewed and applied for directly on the Degelman website.



Apply Today



**DeGelman**

**ENGINEERED TOUGH**



**DeGelman**

**ENGINEERED TOUGH**

**ENGINEERED TOUGH**  
[www.degelman.com](http://www.degelman.com)